

4549013COM Storage Tower

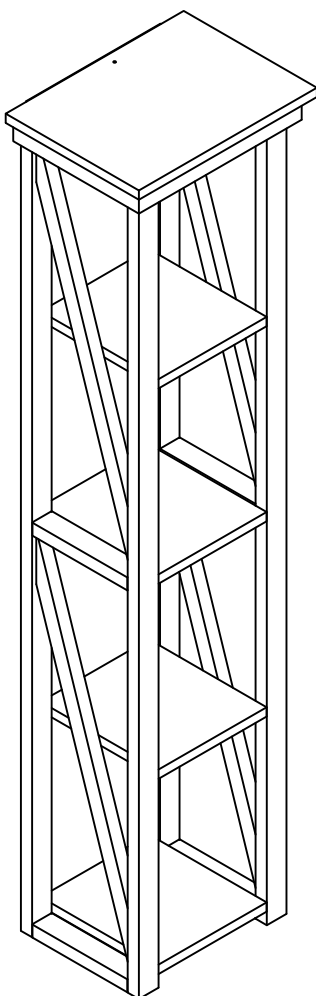

Date of Purchase ___ / ___ / ___
Lot Number:

B344549013COM00



THIS INSTRUCTION BOOKLET CONTAINS **IMPORTANT** SAFETY INFORMATION. PLEASE READ AND KEEP FOR FUTURE REFERENCE.

Do Not Return This Product!

Contact our customer service team for help first.

Call: 1-800-489-3351 (toll free)

Monday-Friday 9am - 5pm CST

Visit: www.systembuild.com



WARNING

- Unit can tip over causing severe injury or death.
- Anchor unit to stud in wall (if instructed to).
- Do Not allow children to climb on unit.
- Put heavy items on lower shelves or drawers.

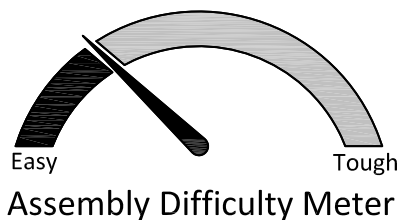

For the latest information on SystemBuild products
follow us at Ameriwood Home



Contact Us!

Do NOT return this product!

Contact our friendly customer service team first for help.



Visit ameriwoodhome.com

Assembly Tips



Helpful Hints

PEOPLE NEEDED FOR ASSEMBLY: **1-2**

ESTIMATED ASSEMBLY TIME: **1 HOUR**

- Open your item in the area you plan to keep it to avoid excessive heavy lifting.
- Identify, sort and count the parts before attempting assembly.
- Compression dowels are lightly tapped in with a hammer.
- Slides are labeled with a **R** (right) and **L** (left) for proper placement.
- Make sure to always face the point on the top of the Cam Lock towards the outer edge.
- Use all the nails provided for the back panel and spread them out equally.
- Back panel must be used to make sure your unit is sturdy.
- Do NOT use harsh chemicals or abrasive cleaners on this item.
- Never push, pull, or drag your furniture.

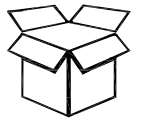

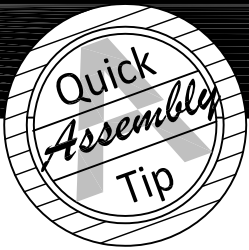

Before You Start

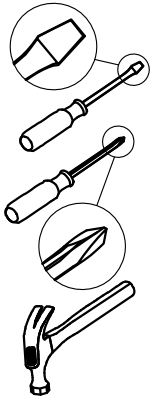

- ✓ Read through each step carefully and follow the proper order
- ✓ Separate and count all your parts and hardware
- ✓ Give yourself enough room for the assembly process
- ✓ Have the following tools: Flat Head Screwdriver, #2 Phillips Head Screwdriver and Hammer
- ✓ Caution: If using a power drill or power screwdriver for screwing, please be aware to slow down and stop when screw is tight. Failure to do so may result in stripping the screw.

Cam Lock Fastening System

This Cam Lock Fastening System will be used throughout the assembly process.

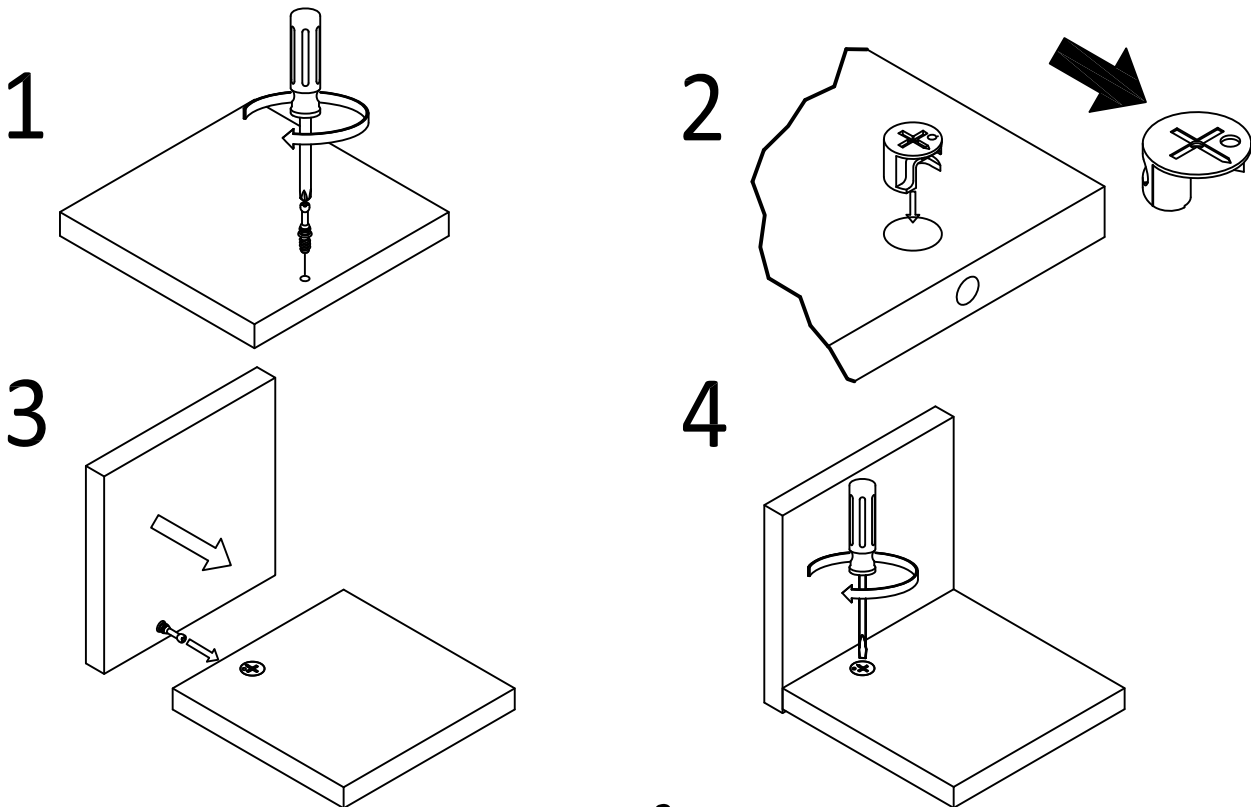

Board Identification

Not actual size

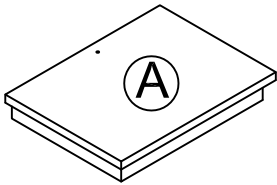

TOP
T4549013010SF

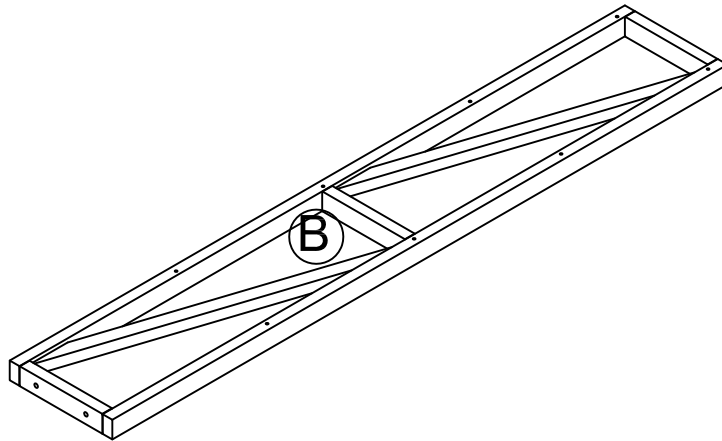

LEFT SIDE FRAME
T4549013020SF

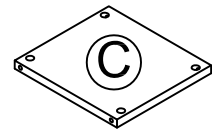

FIXED SHELF
T4549013030SF
QTY: 4 PCS

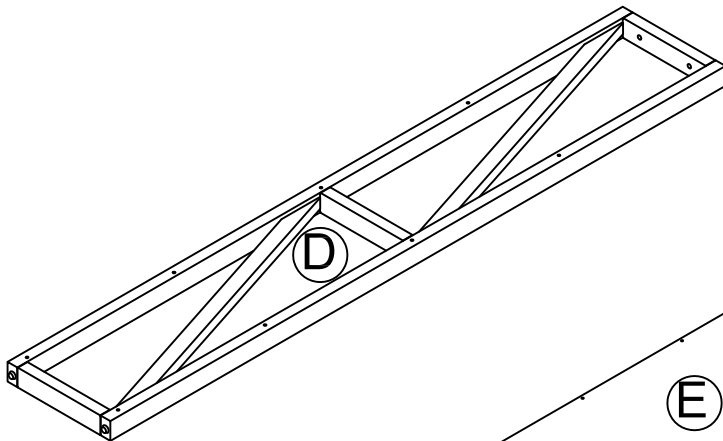

RIGHT SIDE FRAME
T4549013040SF

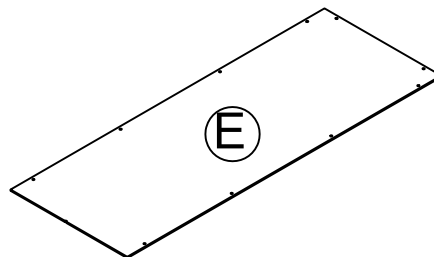

UPPER BACK PANEL
T4549013050SF

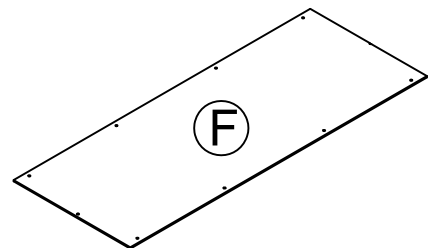

LOWER BACK PANEL
T4549013060SF

Board Identification

Not actual size

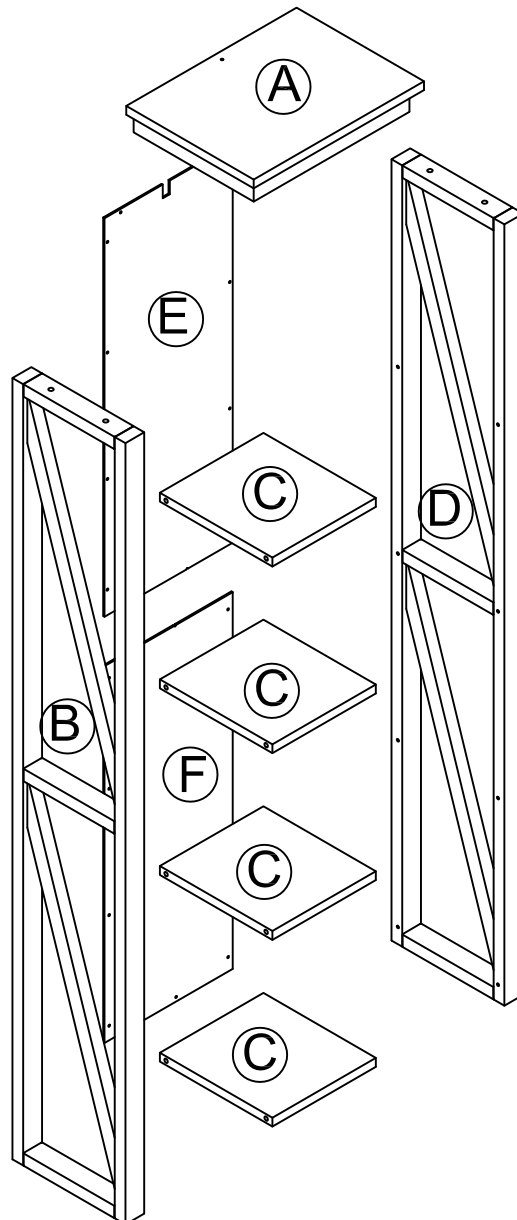

Part List

Actual Size

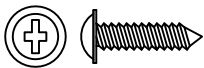

Ø3.5X14mm

①	x 21
---	------

Screw
TSF1201



Ø4X38mm

②	x 1
---	-----

Screw
TSF1210

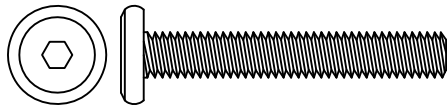

Ø1/4X40

③	x 4
---	-----

Bolt
TSF1607

Not Actual Size

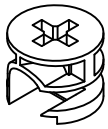

④	x 16
---	------

Cam lock
TSF0308



⑤	x 16
---	------

Cam bolt
TSF0355



⑥	x 1
---	-----

Wall Anchor
TSF0025

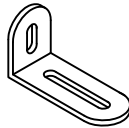

30X19X18XT1.5

⑦	x 1
---	-----

Wall Bracket
TSF2626



Ø7 X10XT1.5mm

⑧	x 4
---	-----

Spring washer
TSF0009



Ø7X13XT1.5mm

⑨	x 4
---	-----

Washer
TSF2402



M4X54mm

⑩	x 1
---	-----

Hex key
TSF0011

STEP 1

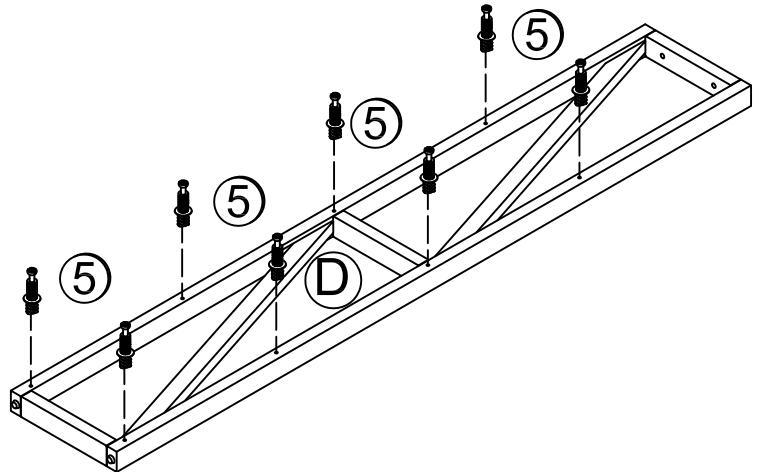
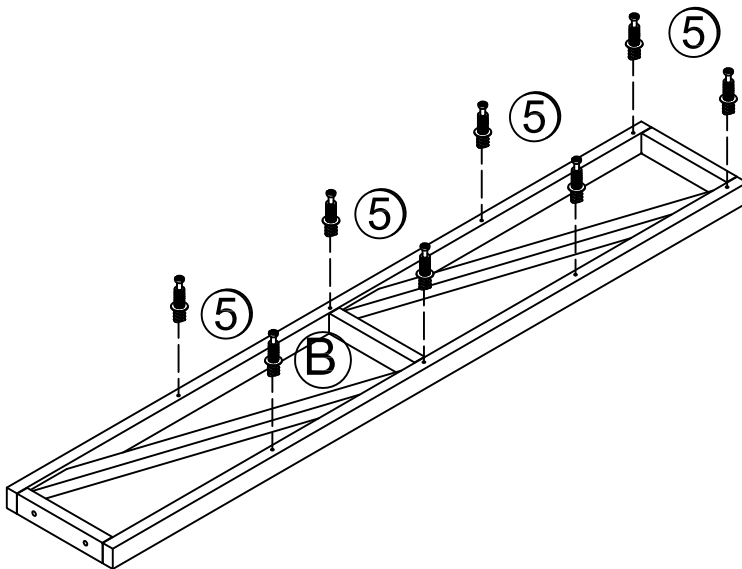
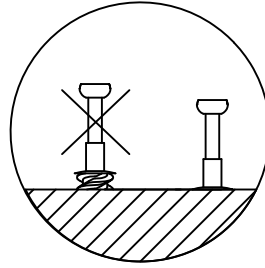
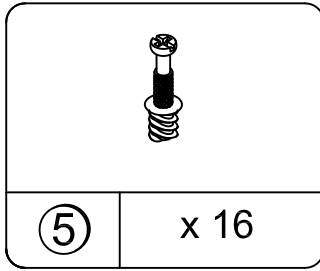
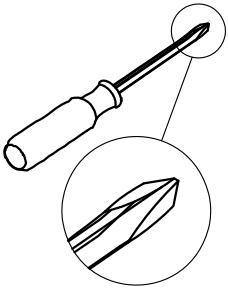

STEP 2

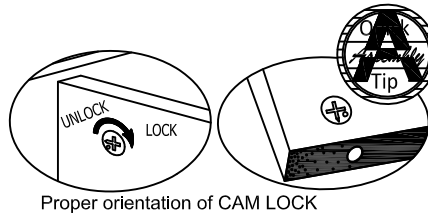
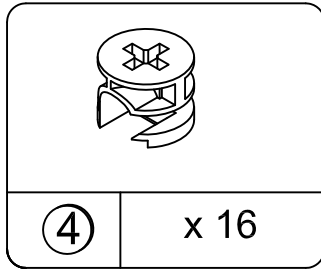
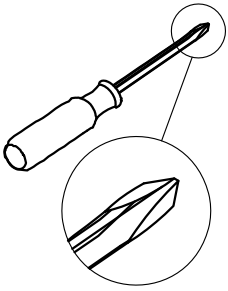

Proper orientation of CAM LOCK

Note:Pre-drilled hole on the back panel toward up.

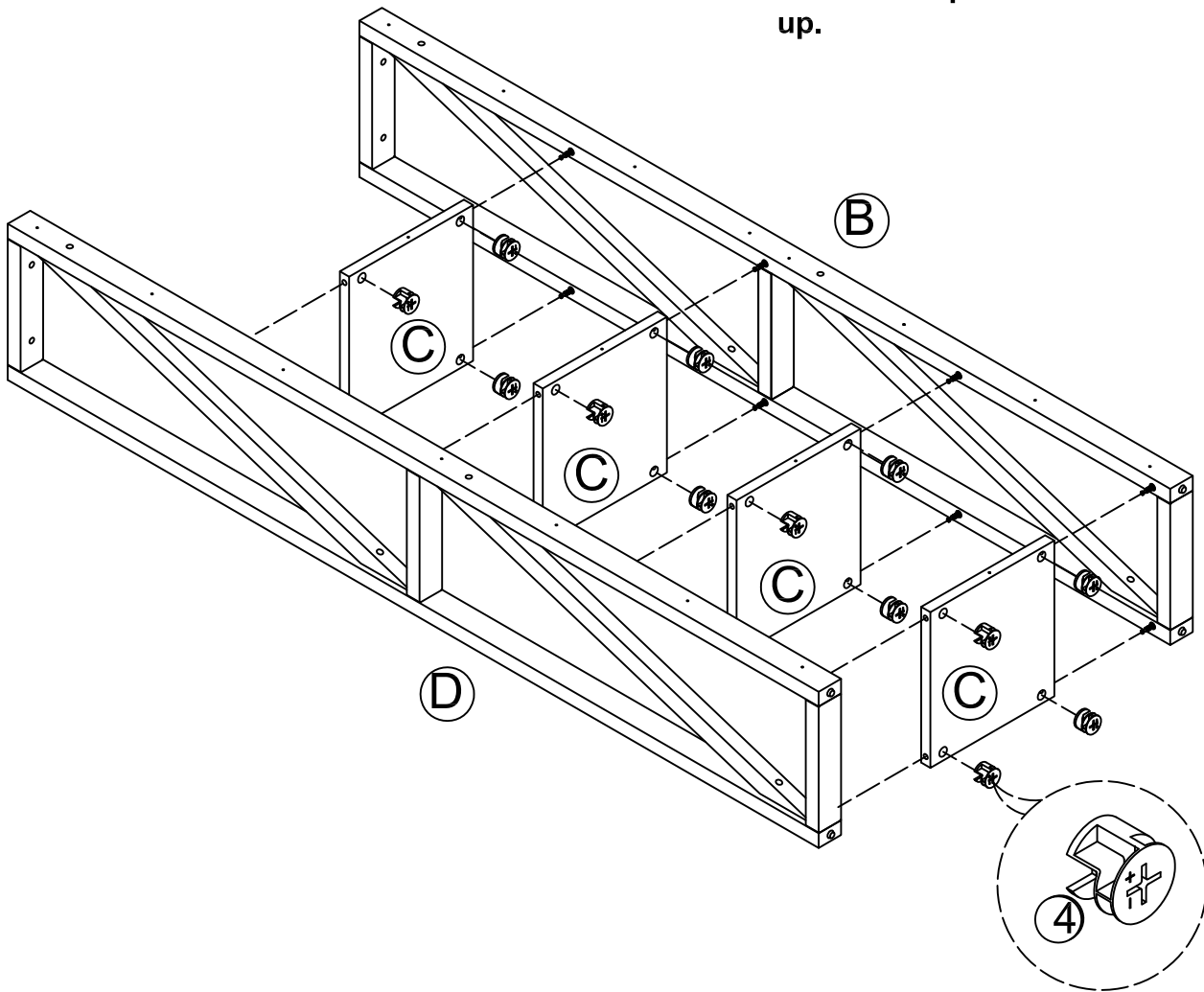

STEP 3

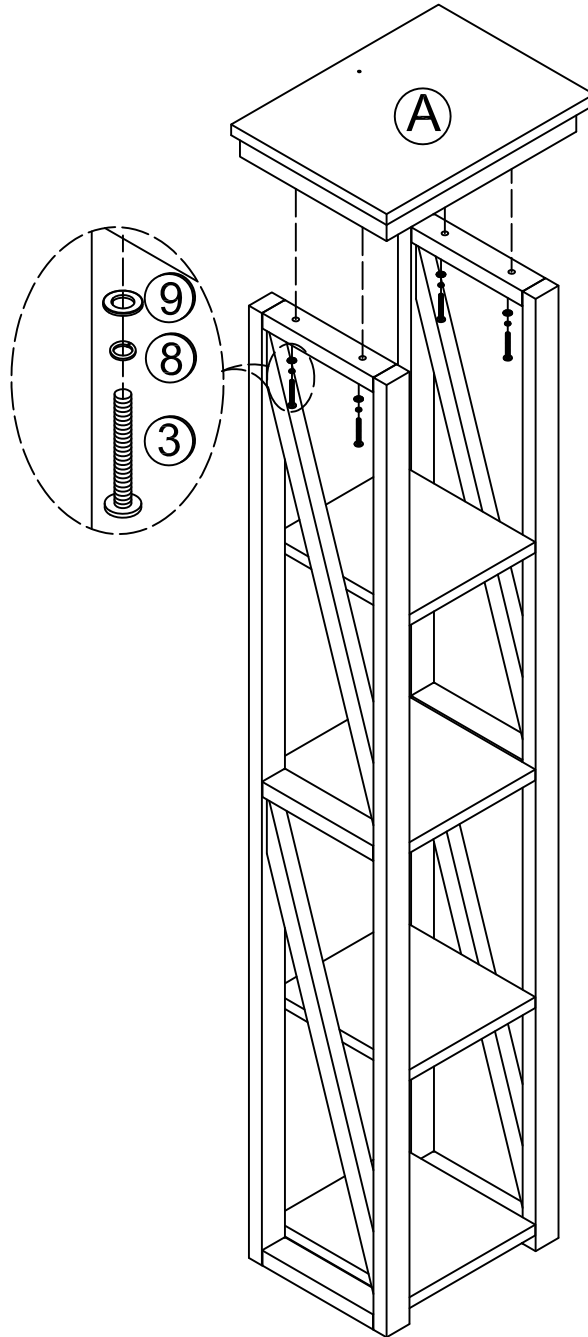
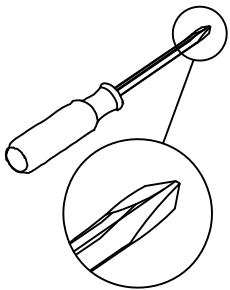
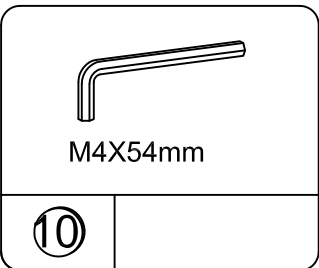
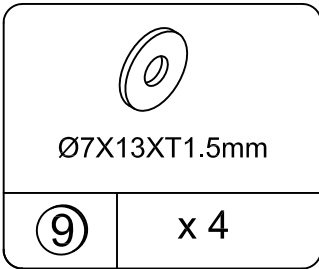
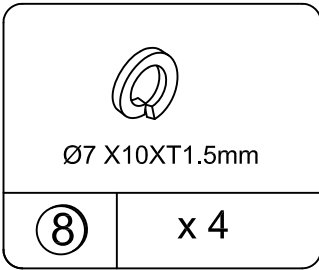
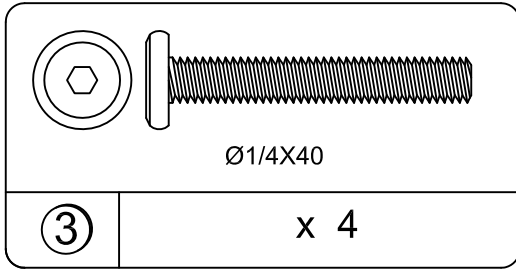

STEP 4

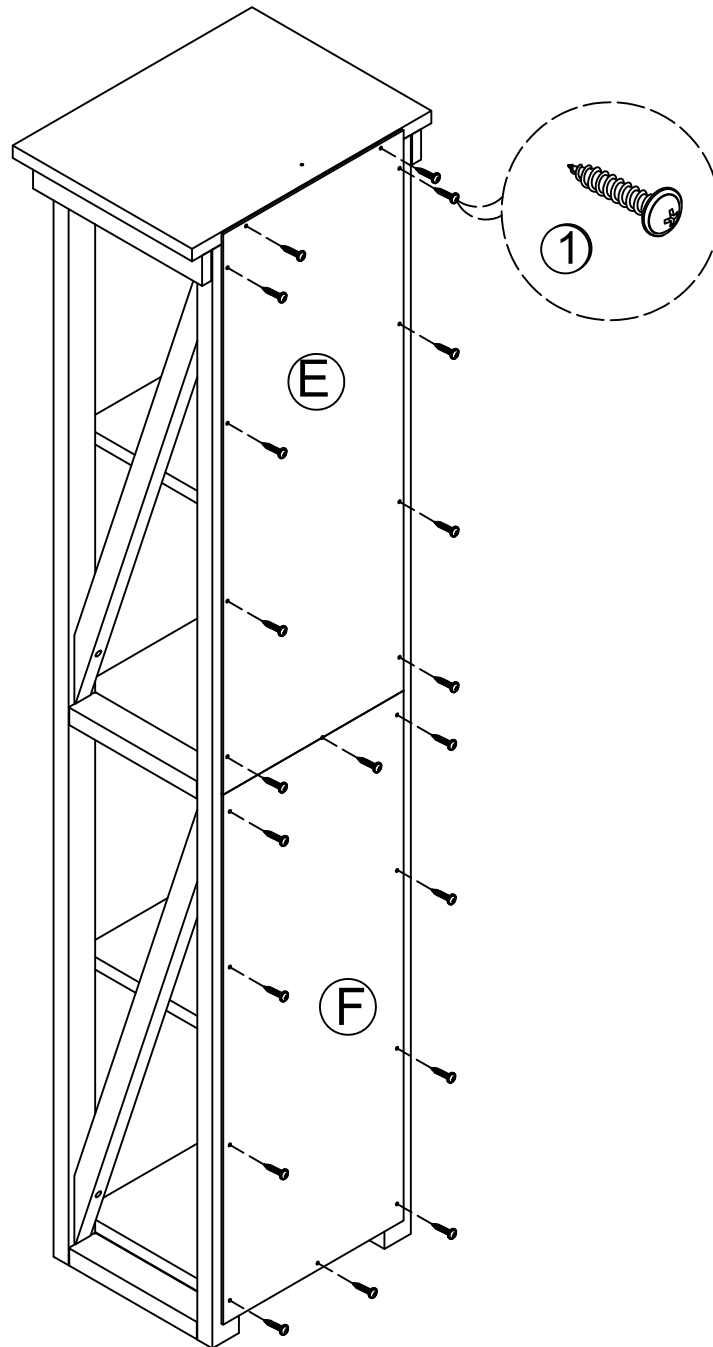
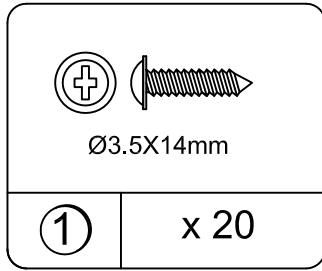
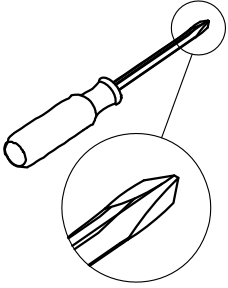

STEP 5

IMPORTANT: THIS UNIT MUST BE SECURE TO THE WALL TO HELP PREVENT TIPOVER. FOLLOW THESE INSTRUCTIONS TO INSTALL THE ANTI-TIPPING SAFETY BRACKET PROVIDED WITH THIS PRODUCT.

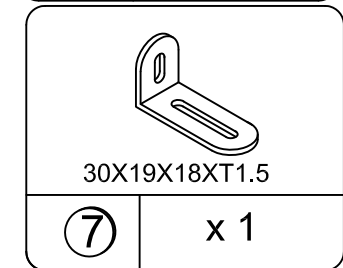
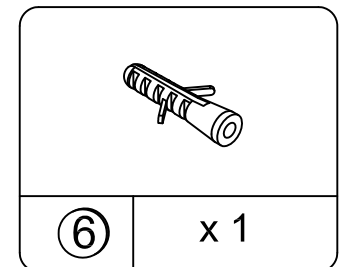
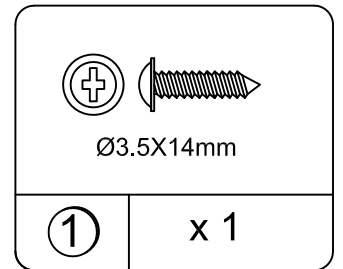
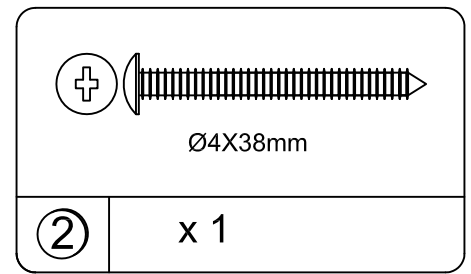
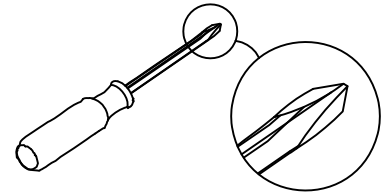
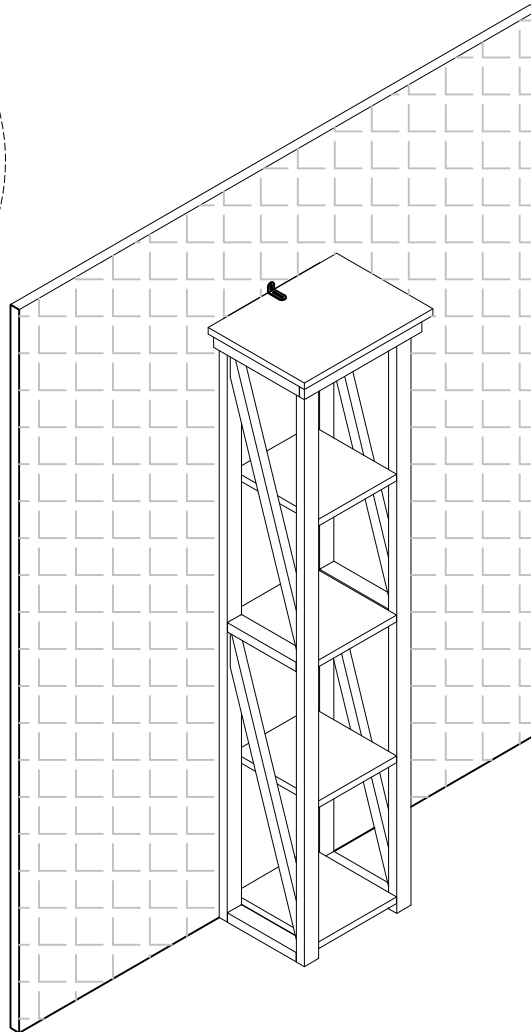
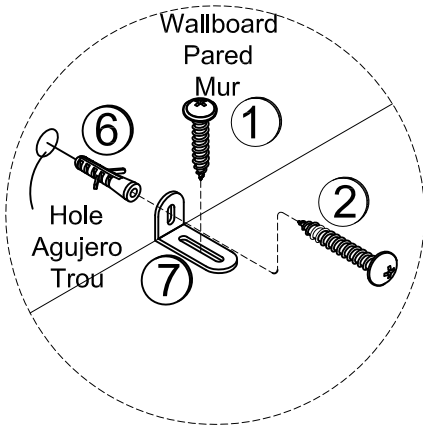

WARNING

Serious or fatal crushing injuries can occur from furniture tipover. To prevent tipover:

- * Install tipover restraint provided
- * place heaviest items in the lowest drawers
- * Unless specifically designed to accommodate, do not set TVs or other heavy objects on the top of this product
- * Never allow children to climb or hang on drawers, door, or shelves
- * Never open more than one drawer at a time

Use of tipover restraints may only reduce, but not eliminate the risk of tipover

For Masonry, Concrete, or other wall materials:
Consult your local hardware store for appropriate anchors to securely attach the safety bracket.

OPTION 1: Attachment into a wall stud (preferred method)

Using a stud finder, locate a stud in the wall. Place your unit against the wall, with the safety bracket (7) aligned in this location. To make driving the screw easier, you can drill a 1/8" diameter pilot hole (3mm) through the safety bracket (7) into the stud. Drive the screw (2) through the safety bracket (7) into the wall stud. Tighten the screw (7) that was not fully tightened in step 1.

OPTION 2: Attachment into drywall

Locate your unit where desired against a wall and mark the wall through the safety bracket (7), then move your unit aside. Drill a 3/16" diameter hole (5mm) into the wallboard. Tap the wall anchor (6) into the hole until it is flush. Move your unit into location and fasten the wall bracket (7) to the wall anchor (6) with the screw (2). Tighten the screw (1) that was not fully tightened in step 1.

Maximum Loads

This unit has been designed to support the maximum loads shown. Exceeding these load limits could cause sagging, instability, product collapse, and/or serious injury.

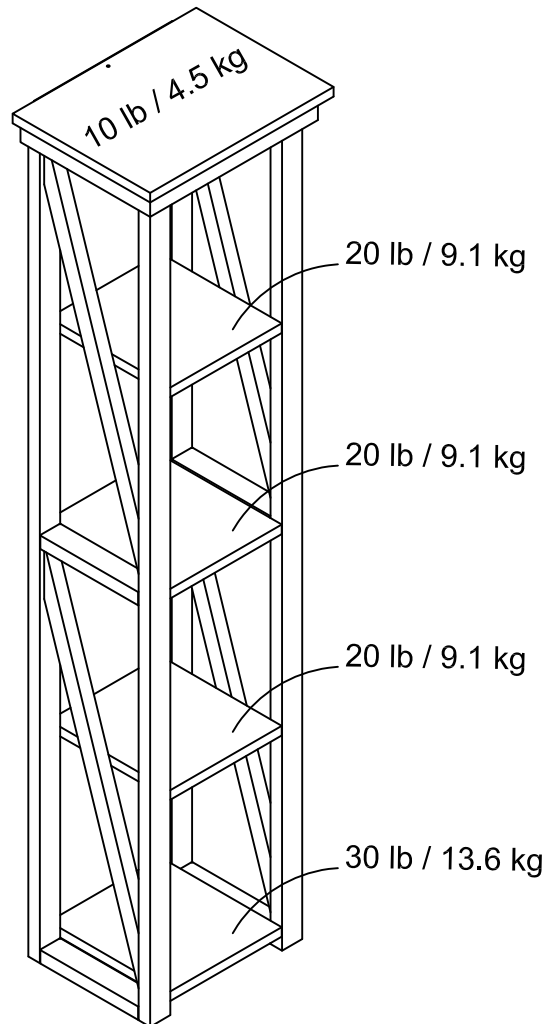

Warning: Risk of injury to persons - do not place a television on this furniture. This furniture is not approved for use with a television.

Certificate of Conformity

1. This certificate applies to the Dorel Home Furnishings, Inc. product identified by this instruction manual.
2. This certificate applies to compliance of this product with the CPSC Ban on Lead-Containing Paint (16 CFR 1303).
3. This product is distributed by: Dorel Home Furnishings, Inc.
410 East First Street South
Wright City, MO 63390
636-745-3351
4. Site of Manufacture: Guangdong China
5. See front page of instruction manual for date of manufacture.

Register your product to receive the following:



- * New trend details - sneak peek on what's new
- * Surveys - have a voice within our community
- * Exclusive deals and discount codes
- * Quick and easy replacement part service

To register your product, visit systembuild.com

5 Star Rating



Visit your local retailer's website, rate your purchased product and leave us some feedback!

We would like to extend a big "Thank You" to all of our customers for taking the time to assemble this Systembuild product, and to give us your valuable feedback.

*Thank
You*

Cubierta Delantera

Este libro de instrucciones contiene información **IMPORTANTE** de seguridad. Por favor lea y manténgalo para referencia en el futuro.

No Regrese este producto! Comuníquese con nuestro amigoso equipo de servicio al cliente para obtener ayuda. Llámenos al: 1-800-489-3351 (Gratis) Lunes - Viernes 9am - 5pm CST

Visitar: www.ameriwoodhome.com

PRECAUCION

Este mueble puede volcarse y causar graves heridas y/o muerte.

Anclar el mueble a un poste de madera en la pared (si esto se requiere).

No Permita que los niños monten el mueble.

Mantenga los artículos más pesados en los cajones de abajo.

Consejos Útiles (página 2)

- Abra su artículo en el área donde usted planea utilizarlo para evitar levantar y moverlo menos
- Identificar, ordenar y contar las piezas antes de intentar ensamblar
- Las clavijas de compresión se golpean con un martillo
- Las diapositivas están marcadas con una R (derecha) y L (izquierda) para la colocación correcta
- Asegúrese de que siempre este el punto localizado en la parte superior de bloqueador de leva este volteado hacia borde exterior
- Utilizar todos los clavos para el panel de atrás y distribuirlos por igual
- El panel de atrás debe utilizarse para asegurarse de que la unidad quede fija y firme
- No use químicas fuertes ni limpiadores abrasivos en este artículo
- Nunca empuje, tire ni arrastre los muebles

Antes de Que Empieces (página 3)

- Lea cuidadosamente cada paso y siga el orden correcto

- Separar y contar todas sus piezas y hardware

- Dése suficiente espacio para el proceso de ensamble

- Tenga las siguientes herramientas: destornillador de cabeza plana, #2 cabeza Phillips

Destornillador y martillo

- Precaución: Si usa un taladro electrónico o un destornillador eléctrico para atornillar, por favor asegúrese que deje de atornillar cuando el tornillos este apretado. Fallar hacer esto puede causar barrer el tornillo.

Sistema de fijar el bloqueo de leva (página 3)

Esta sistema de fijar el bloqueo de leva sera usado en todo el proceso ensamble.

Identificación de los Paneles (Página 4)

Este no es el tamaño real

- (A) Arriba
- (B) LADO IZQUIERDO DEL PANEL
- (C) ESTANTE FIJO
- (D) PANEL LATERAL DERECHO
- (E) PANEL TRASERO SUPERIOR
- (F) PANEL TRASERO INFERIOR

Lista de Piezas (Página 6)

Tamaño real

- (1) TORNILLO
- (2) TORNILLO
- (3) PERNO DE

Este no es el tamaño real

- (4) CERRADURA DE LA LEVA
- (5) PERNO DE LEVA
- (6) ANCLAJE DE PARED
- (7) SOPORTE DE PARED
- (8) ARANDELA DE RESORTE
- (9) LAVADORA
- (10) LLAVE HEXAGONAL

Página 12

CARGA MAXIMA

Esta unidad ha sido diseñada para soportar la carga máxima anotada. El exceder estos límites puede causar inestabilidad, colapsarse y/o causar serias lesiones.

ADVERTENCIA: Riesgo de lesiones a las personas - no coloque un televisor sobre muebles. Este mueble no está aprobado para su uso con un televisor.

Página 13

Registre su producto para recibir lo siguiente:

- * Detalles de nuevas tendencias - Vistazo a lo nuevo
- * Encuestas - alec su voz entre su comunidad
- * Códigos de ofertas y descuentos exclusivos
- * Fácil y rápido servicio de partes de remplace

Para registrar su producto, visite ameriwoodhome.com

Clasificación de 5 estrellas

Visite el sitio web de su tienda local, califique su comprado y denos sus comentarios!

Nos gustaría enviar un gran "Agradecimiento" a todos nuestros clientes por tomarse el tiempo de ensamblar este producto de Ameriwood Home, y por darnos sus valiosos comentarios.

Gracias

Couverture Avant

CE LIVRET D'INSTRUCTION CONTIENT DES INFORMATIONS **IMPORTANTES** SUR LA SÉCURITÉ. VEUILLEZ LIRE ET GARDER POUR UNE RÉFÉRENCE FUTURE

Ne retournez pas ce produit! Contactez notre équipe de service à la clientèle amicale d'abord pour obtenir de l'aide.

Appelez-nous: 1-800-489-3351 (sans frais) du Lundi au Vendredi de 9h à 17h Heure Centrale

Visitez: www.ameriwoodhome.com

ATTENTION

Le meuble peut basculer et causer des blessures graves ou la mort.

Ancrer le meuble à une planche murale dans le mur (si indiqué).

Ne laissez pas les enfants grimper sur le meuble.

Placez les articles lourds sur les étagères ou dans les tiroirs inférieurs.

Astuces Utiles (page 2)

-Ouvrez votre article dans la zone que vous prévoyez de le garder pour moins de levage lourd

-Identifier, trier et compter les pièces avant d'essayer d'assembler

-Les goujons de compression sont taraudés avec un Marteau

-Les glissières sont marquées d'un R (droit) et d'un L (gauche) pour un bon placement

-Assurez-vous toujours de faire face la pointe situé sur le haut de la Serrure de Came vers le bord extérieur

-Utiliser tous les clous fournis pour le panneau arrière et les répartir également

-Le panneau arrière doit être utilisé pour vous assurer que votre appareil est robuste

-N'utilisez pas de produits chimiques agressifs ou de nettoyeurs abrasifs sur cet appareil

-Ne jamais pousser, tirer, ou faire glisser votre meuble

Avant de Commencer (page 3)

-Lisez attentivement chaque étape et suivez le bon ordre

-Séparez et comptez toutes vos pièces et matériaux

-Donnez-vous suffisamment de place pour l'assemblage

-Avoir les outils suivants: tournevis à tête plate, #2 tournevis Phillips, et Marteau

-Attention: Si vous utilisez une perceuse électrique ou un tournevis électrique pour visser, veillez à ralentir et arrêter lorsque la vis est bien serrée. Le non-respect de cette consigne peut endommager la vis.

Système de Fixation de Came (page 3)

Ce Système de Fixation de Came sera utilisé tout au long de l'assemblage

Identification des matériaux (Page 4)

Pas de taille réelle

- (A) Retour au début
- (B) PANNEAU LATÉRAL GAUCHE
- (C) TABLETTE FIXE
- (D) PANNEAU LATÉRAL DROIT
- (E) PANNEAU ARRIÈRE SUPÉRIEUR
- (F) PANNEAU ARRIÈRE

Liste des pièces (Page 6)

Taille réelle

- (1) VIS
- (2) VIS
- (3) BOULON

Pas de taille réelle

- (4) SERRURE À CAME
- (5) BOULON DE CAM
- (6) CHEVILLE
D'ANCRAGE
- (7) SUPPORT MURAL
- (8) RONDELLE À
RESSORT
- (9) MACHINE À LAVER
- (10) CLÉ
HEXAGONALE

Page 12

CHARGES MAXIMALES

Ce meuble a été conçu pour supporter les charges maximales indiquées. En excédant ces limites de charge, le meuble pourrait devenir instable, s'effondrer, et/ou causer des blessures graves.

AVERTISSEMENT : Risque de blessure corporelle - ne pas placer une télévision sur ce meuble. Ce meuble n'est pas approuvé pour une utilisation avec une télévision.

Page 13

Enregistrez votre produit pour recevoir les éléments suivantes:

- * Détails sur les nouvelles tendances - un aperçu sur les nouveautés
- * Sondages - avoir une voix au sein de notre communauté
- * Offres exclusives et codes promo
- * Service de pièces de rechange rapide et facile

Pour enregistrer votre produit, visitez ameriwoodhome.com

5 Étoiles

Visitez le site Web de votre détaillant local, évaluez votre produit acheté et laissez-nous quelques commentaires !

Nous tenons à offrir un grand "Merci" à tous nos clients pour avoir pris le temps d'assembler ce produit "Ameriwood Home", et de nous donner vos commentaires précieux.

Merci